











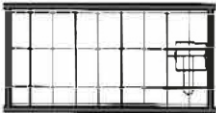
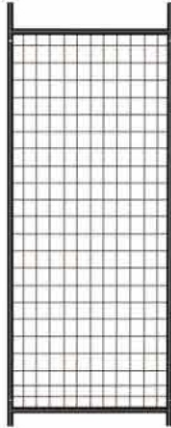
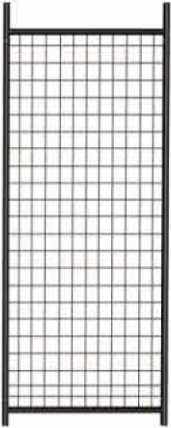



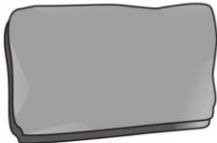







SOBKY TYP 4

A*1			B*7	C*4
				
A-1*1	A-2*1	A-3*1		
D*5		E*2	N*1	W*2
				
D-1*5	D-2*5			

F1*53	F2*2	F3*4	F4*4	K*2	H*48
					
F1-1*53	F2-1*2	F3-1*4		K	H
					
F1-2*53	F2-2*2	F3-2*4			
M*1	P*1	J*12	I*16		
					
Lock	Lock End	Rope			

1.

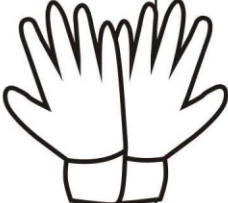
1-①

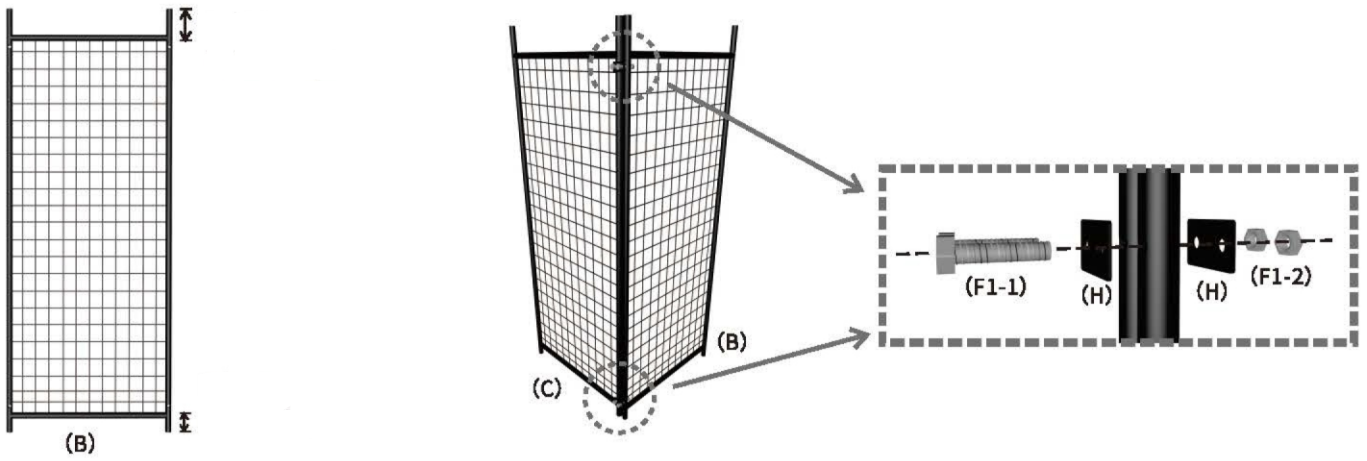

1-②

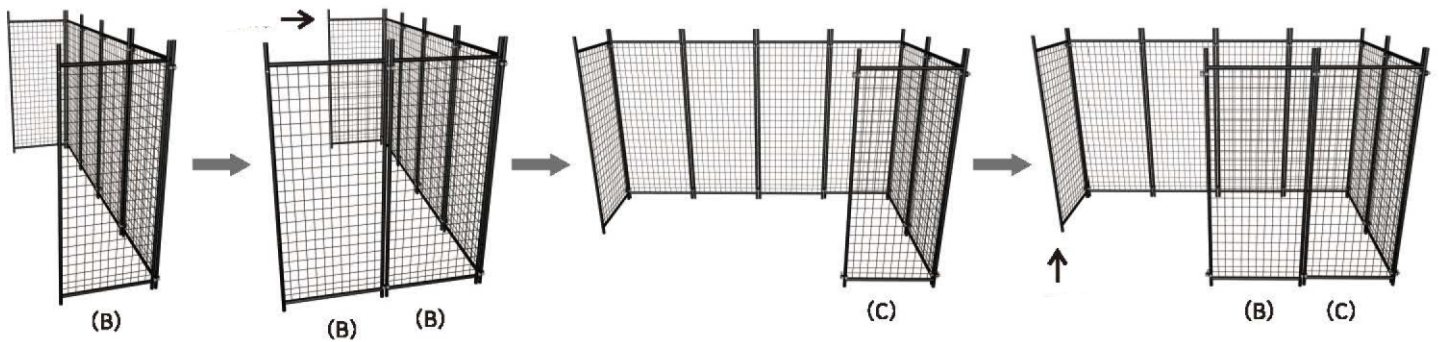
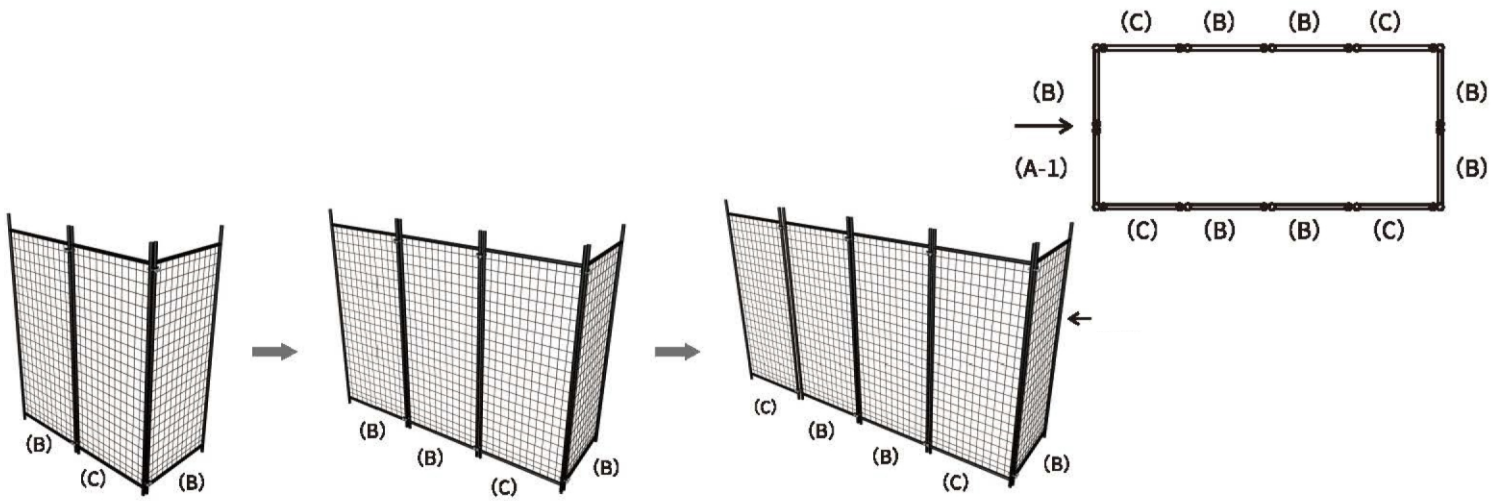

1-③

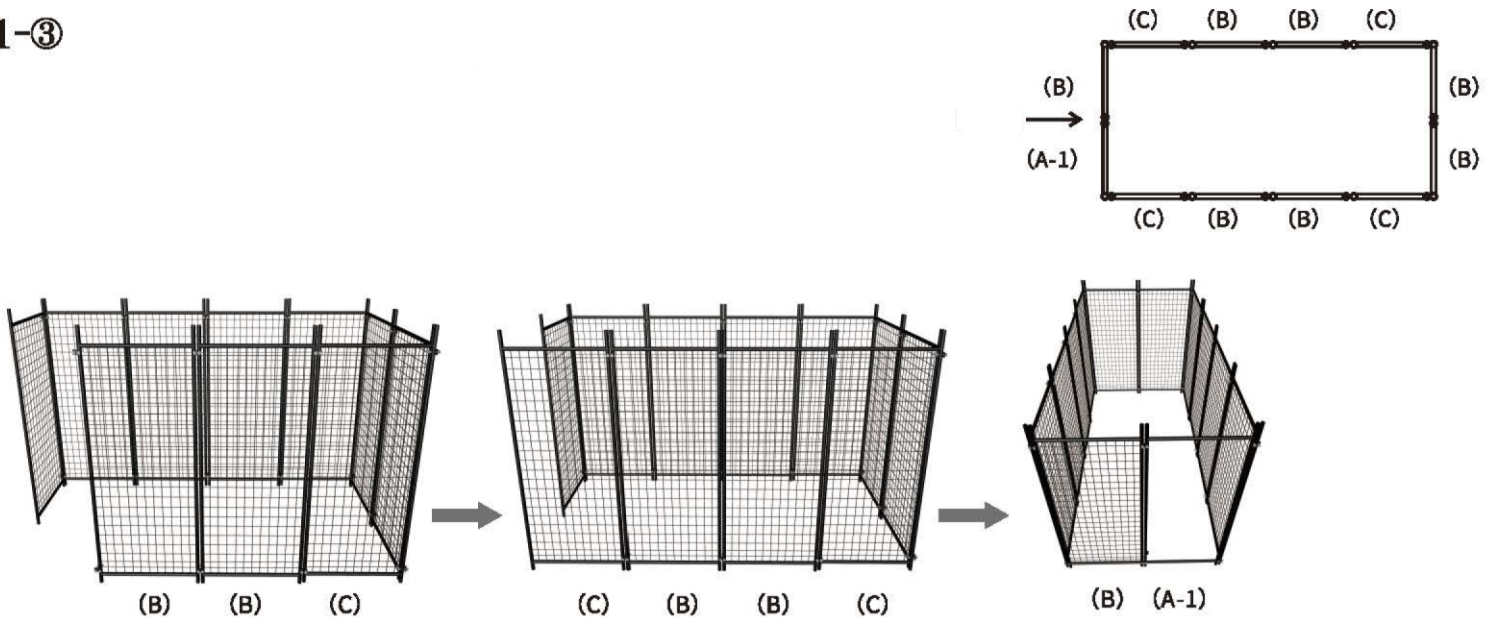

2.

2-①

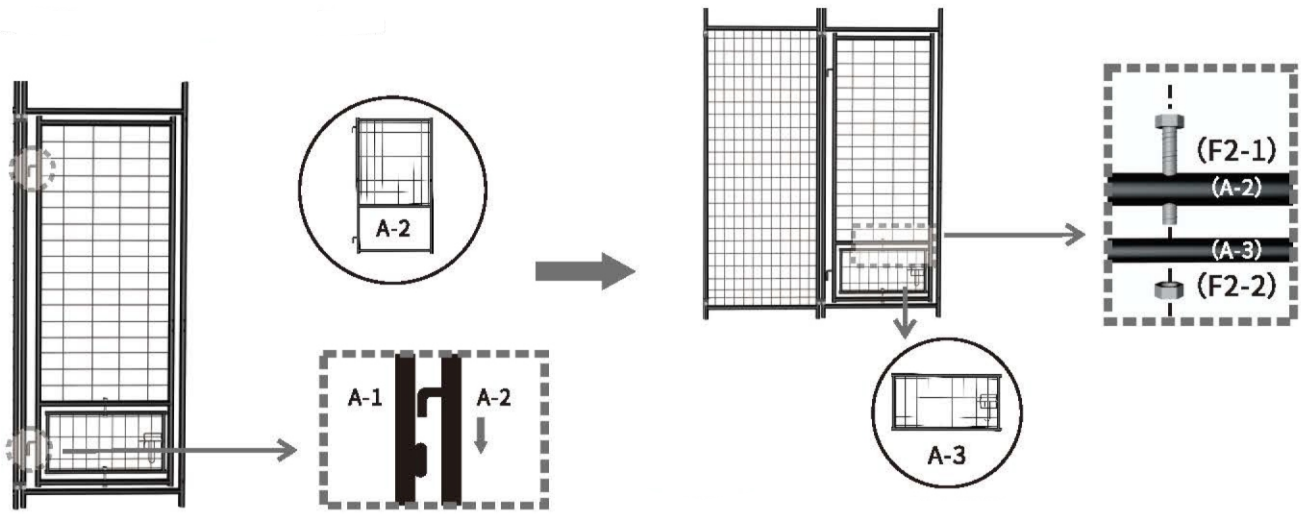

2-②

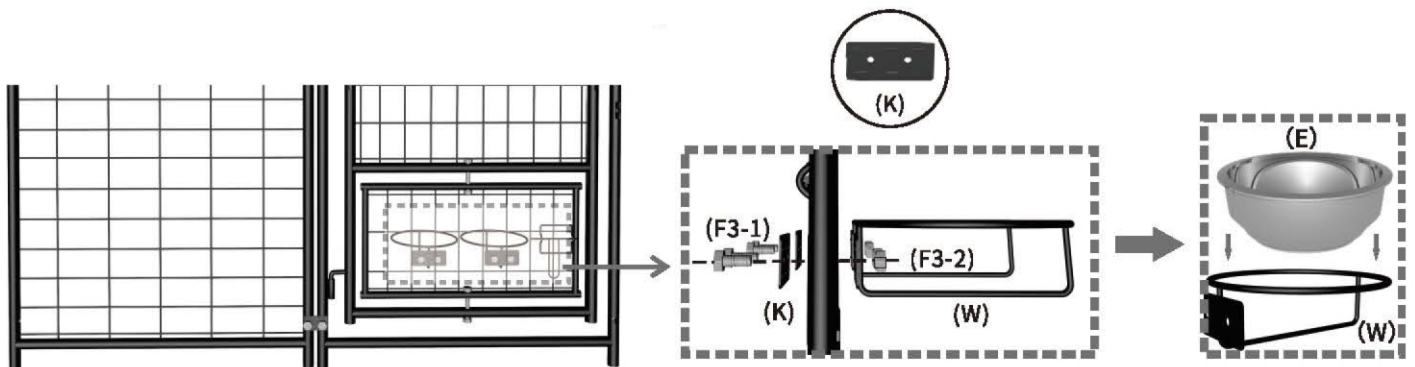

2-③

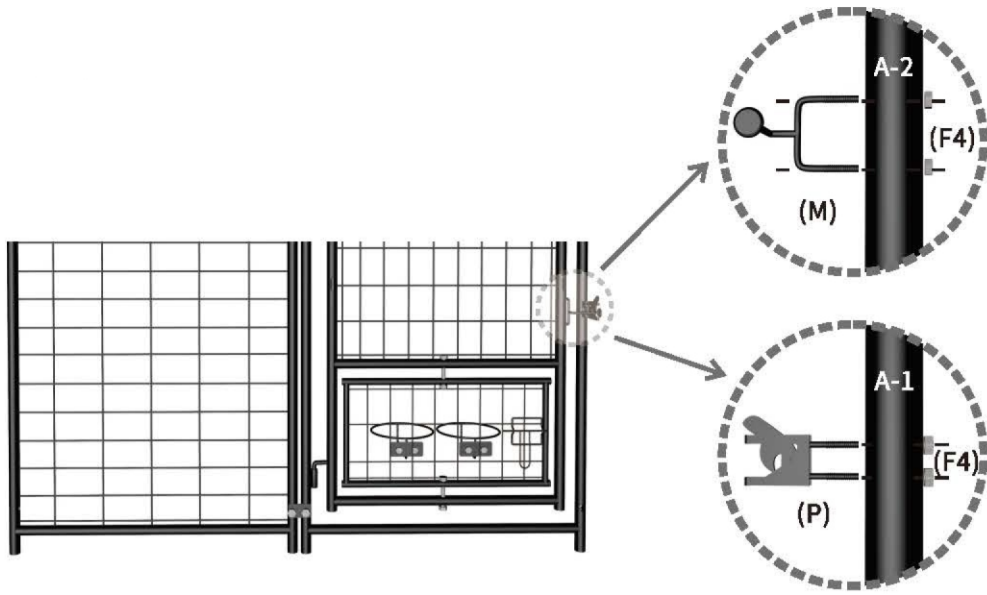

2-④

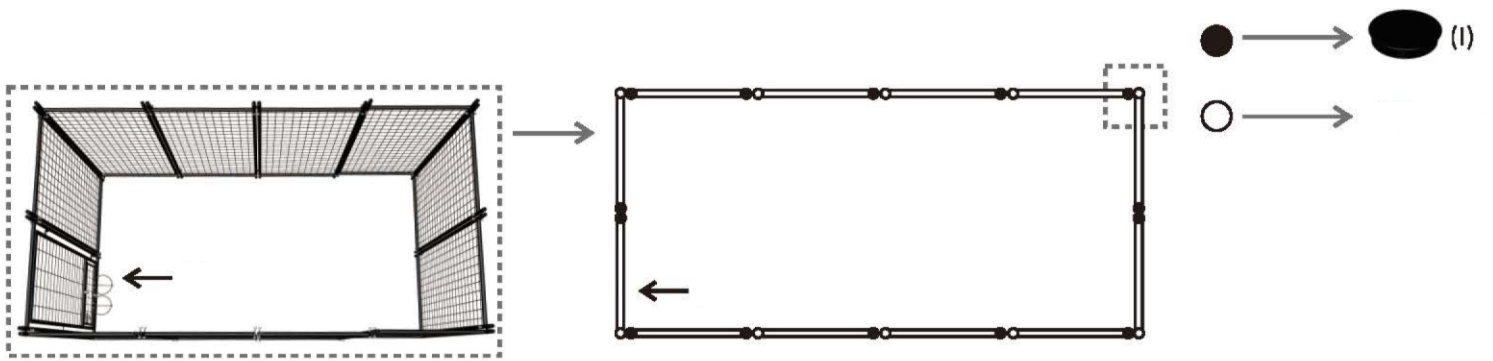

3.

3-①

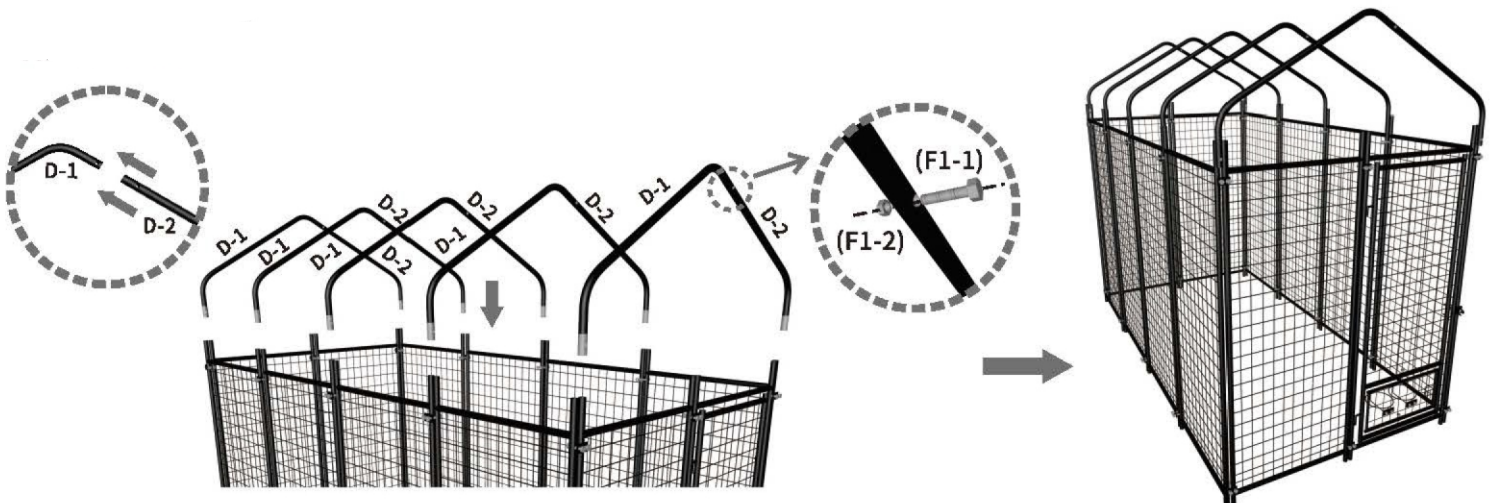

3-②

